

Art. Nr. 2810250

1/6



25.04.2019

Groundplan - Grundplan - Plan de masse - Planimetria - Plattegrond -
Põhiplaan

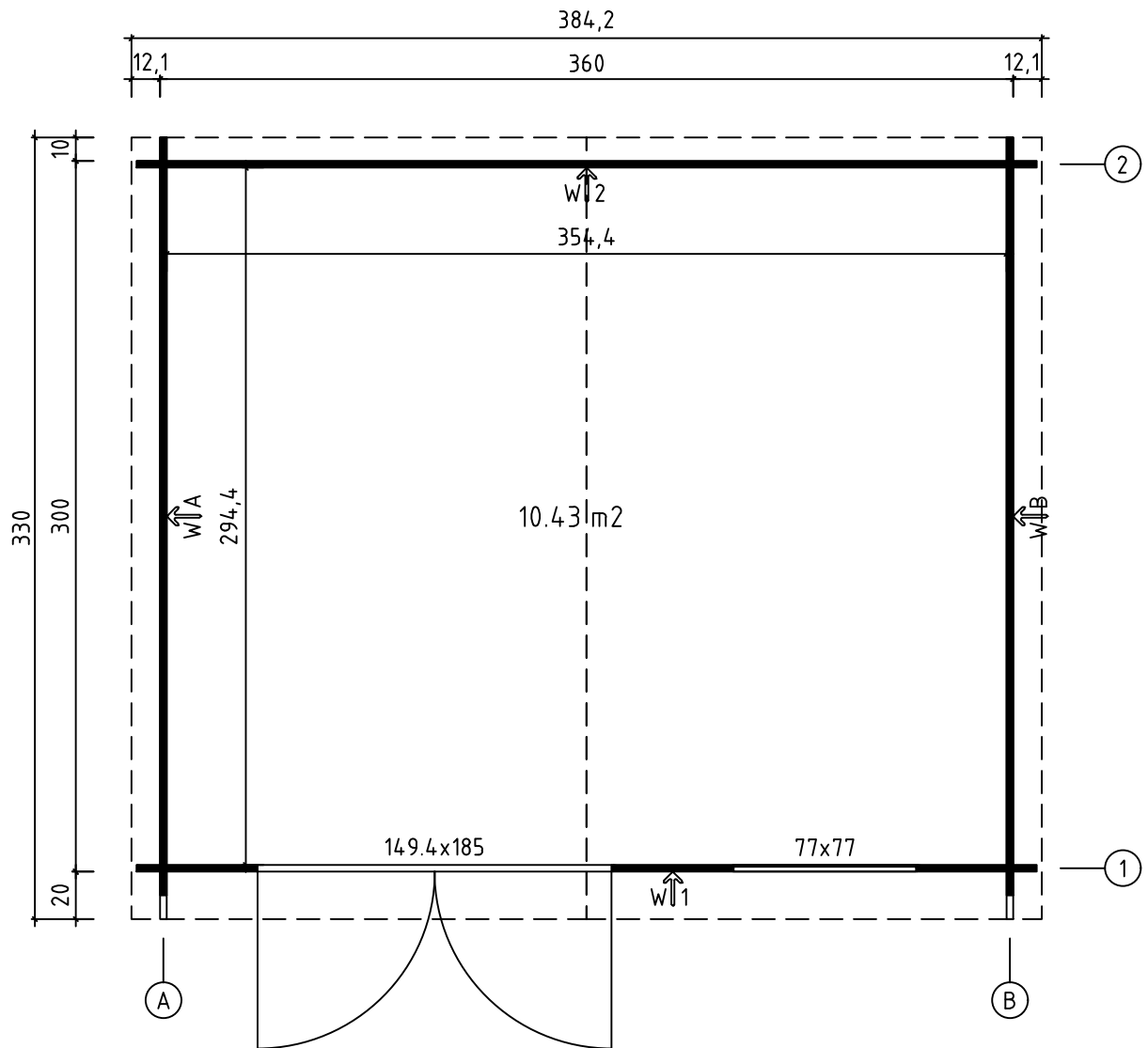



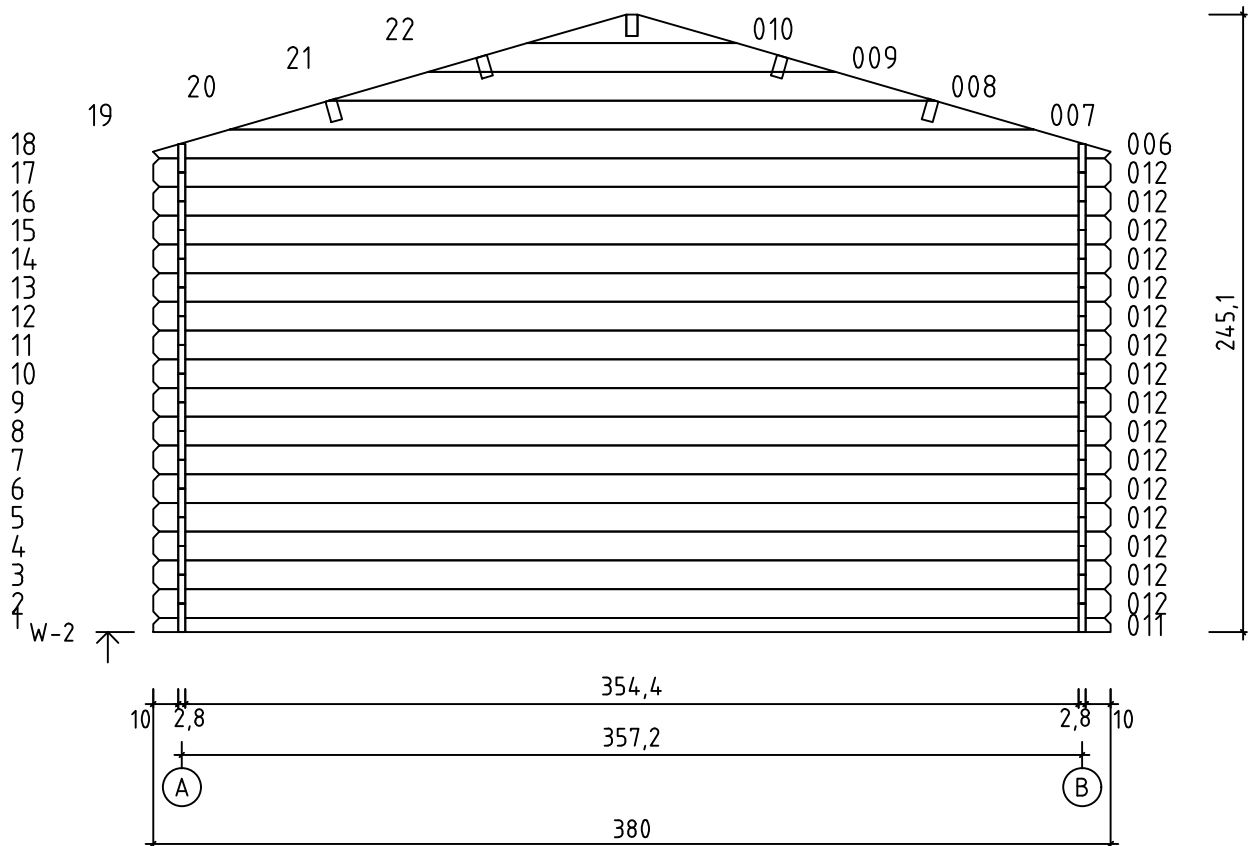
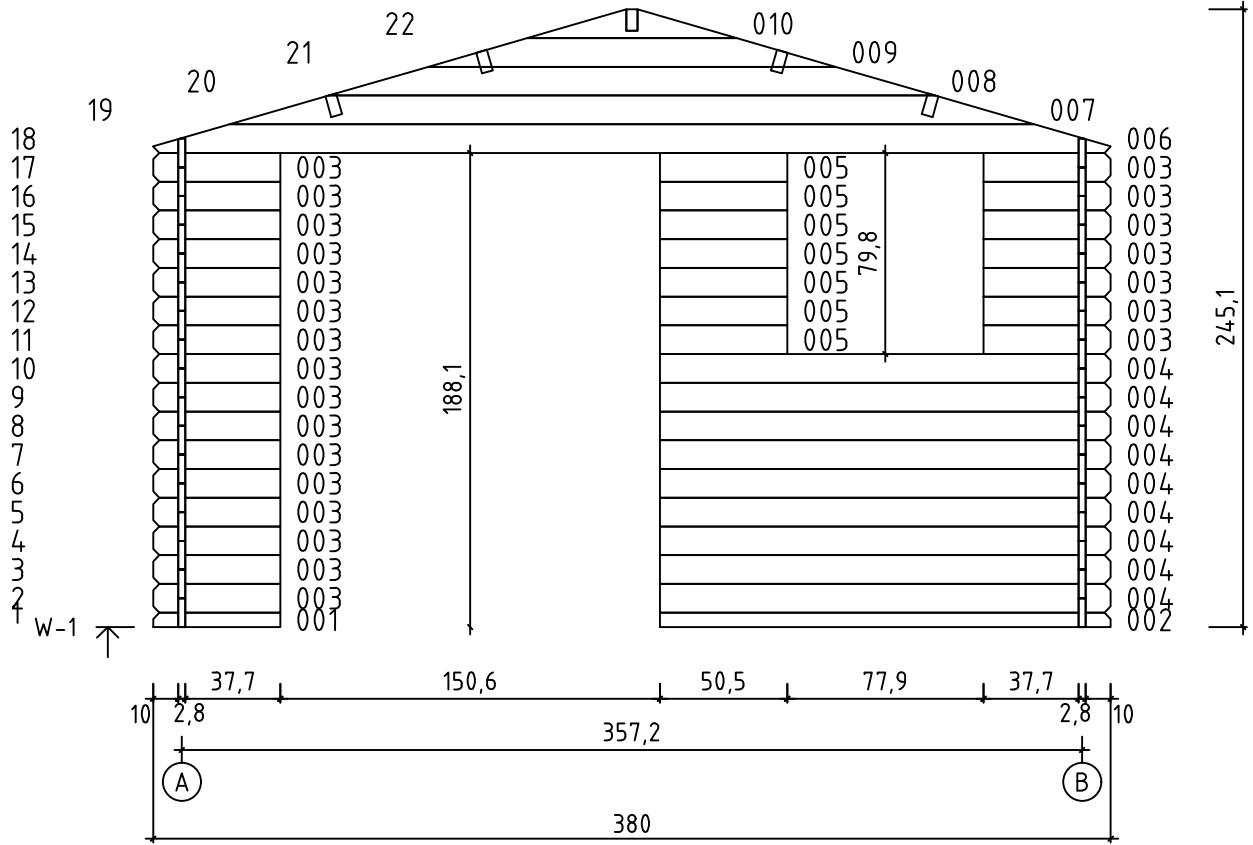



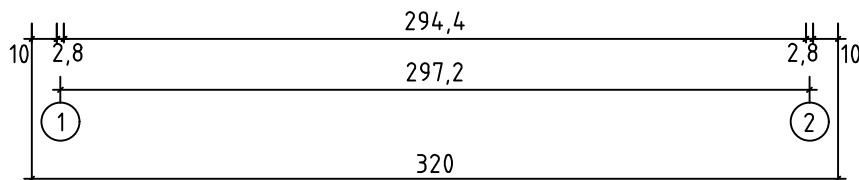
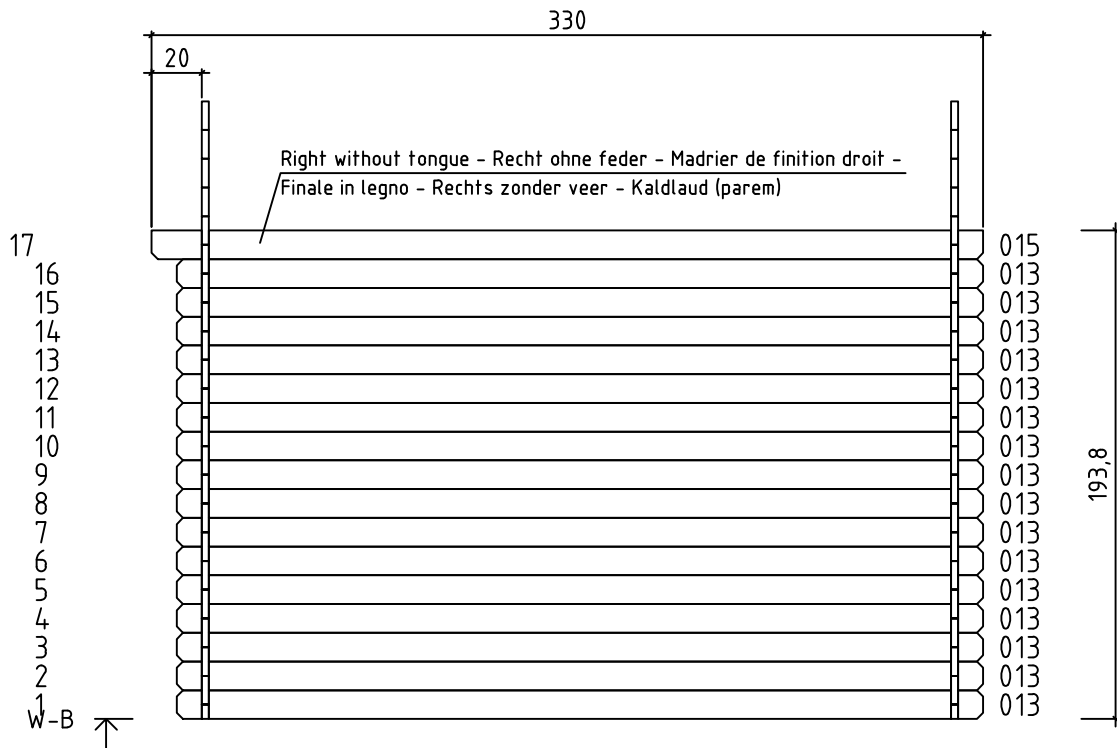
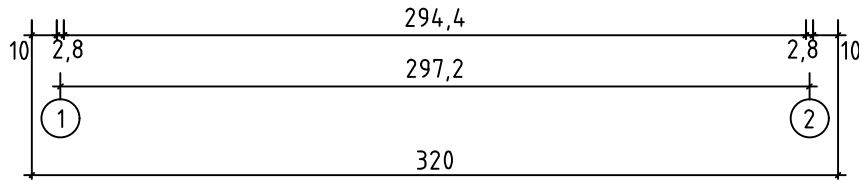
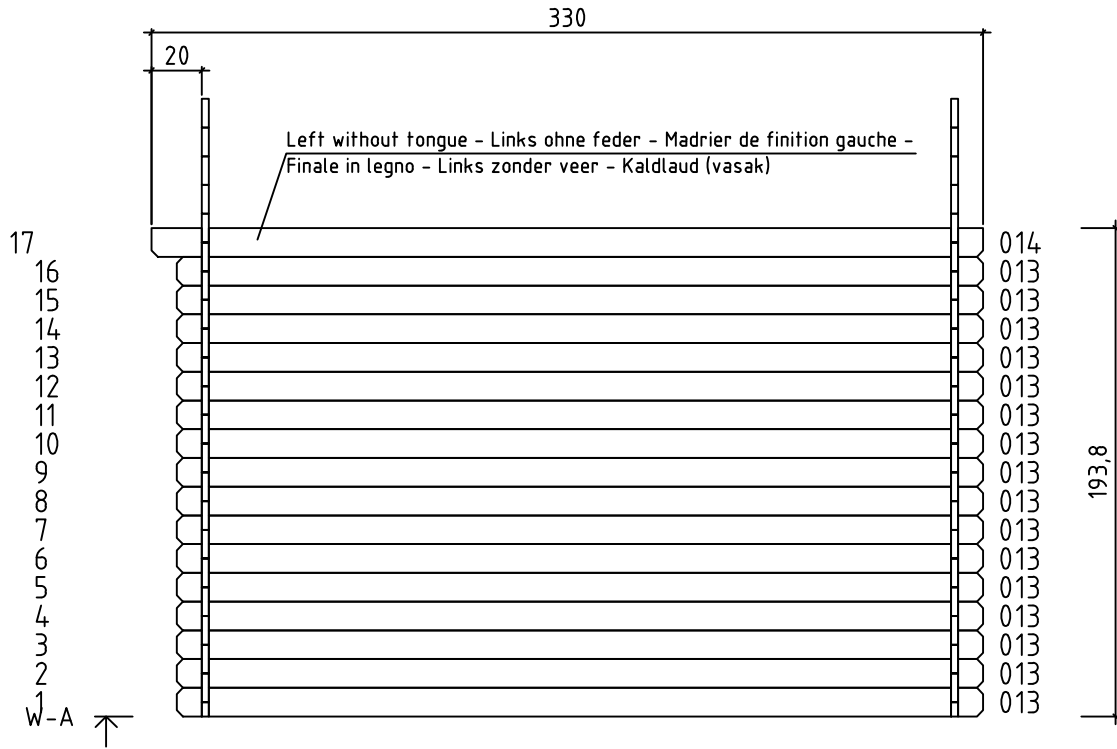

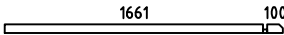

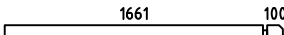

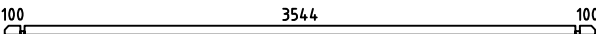
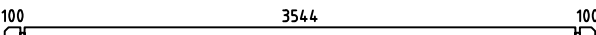
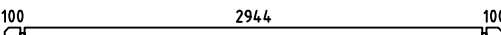
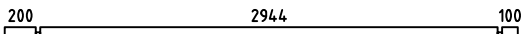
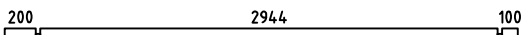
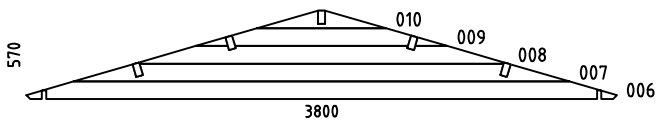
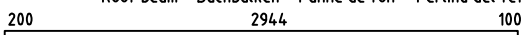

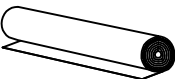

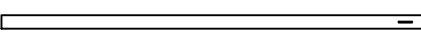
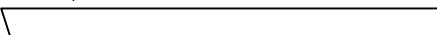
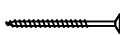
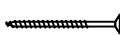
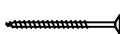
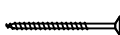
Art. Nr. 2810250

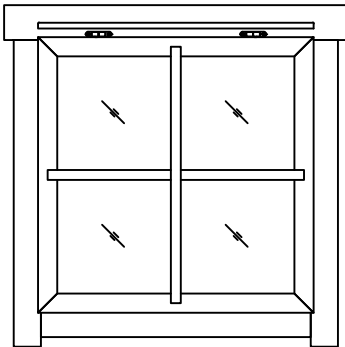
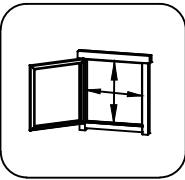
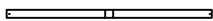
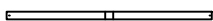





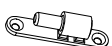
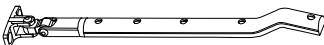

Art. Nr. 2810250

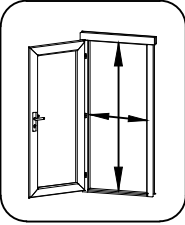
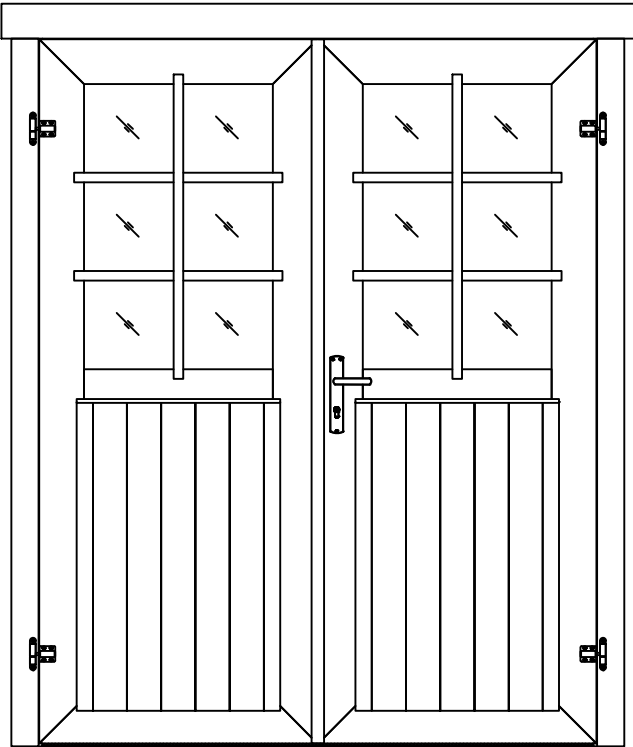

| Pos | 25.04.2019 Piece list - Stückliste - Liste des pièces - Elementi - Stuklijst - Tükitalabel Art. Nr. 2810250 5/6 | Q | P (mm) | L (mm) |
|--------------|--|--------|-----------|-----------|
| 001 |  | 1 | 28x57 | 505 |
| 002 |  | 1 | 28x57 | 1789 |
| 003 |  | 23 | 28x114 | 505 |
| 004 |  | 9 | 28x114 | 1789 |
| 005 |  | 7 | 28x114 | 505 |
| 011 |  | 1 | 28x57 | 3800 |
| 012 |  | 16 | 28x114 | 3800 |
| 013 |  | 32 | 28x114 | 3200 |
| 014 |  | 1 | 28x120 | 3300 |
| 015 |  | 1 | 28x120 | 3300 |
| W1-1 W2-1 |  | 1 1 | | |
| A-PR1 | Roof beam - Dachbalken - Panne de toit - Perlina del tetto - Gordingen / dakbalk - Pärilin  | 5 | 44x120 | 3300 |
| | Roof boards - Dachbretter - Voliges - Perlina per tetto - Dakhout - Katuselaud  | 74 | 90x15 | 2000 |
| | Roofing felt fillet - Dachpappenleiste - Baguette de fixation du feutre bitumeux - Asse per fissaggio guaina bituminosa - Afdekljst asfaltpapier - Katusepapiilist  | 4 | 15x45 | 2050 |
| DPP-1 | Roofing felt (strip) - Dachpappe (bahnen) - Feutre bitumeux (bande) - Cartone catramato - Asfaltpapier (baan) - Katusepapp  | 5 | | 3400 |
| TB-1 | Fascia board - Traufbrett - Bandeau de toit - Finitura lati tetto - Gevellijst - Räästalaud  | 2 | 15x45 | 3300 |
| KFS-1 | Storm protection - Sturmleiste - Latte anti-tempete - Protezione anti vento - Stormverankering / beveiliging - Tormikinnitusliist  | 4 | 22x45 | 2050 |
| | Gable moulding - Giebelleiste - Planche de rive - Finitura per frontale e retro del tetto - Gevellijst - Viilulaud  | 4 | 15x120 | 2050 |
| HS8 | Screw for gable segment - Schrauben für deckblatt - Vis pour fixation losange de finition - Viti x frontali tetto - Schroef voor gevelpunt segment - Krugi rombile  | 4 | 3.5x35 | |
| HS9 | Screw for gable moulding - Schrauben für giebelleiste - Vis pour fixation planche de rive - Vite per fissare finiture davanti e dietro del tetto - Schroef voor gevellijst - Krugi viilulauale  | 32 | 3.5x50 | |
| HS12 | Screw for fascia boards - Schrauben für traufbretter - Vis pour fixation bandeau de toit - Viti x striscia del tetto - Schroef voor gevellijst - Krugi räästalauale  | 16 | 4x40 | |
| HS18 | Screw for gable - Schrauben für giebel - Vis pour fixation des pignons - Viti per timpano - Schroef voor gevelpunt - Krugi kelba kinnitamiseks  | 4 | 5x120 | |

| Pos | 14.03.2018 | Piece list - Stückliste - Liste des pièces - Elementi - Stuklijst - Tükítabel 770x770 AK.1.104.SVA.c SGA | 1/1 | Q | P (mm) | L (mm) |
|------|---|--|-----|--------|-----------|-----------|
| | | Glass size - Glasgröße - Taille de la vitre - Misura del vetro - Glas afmeting - Klaasi mõõt: 626x626 mm   670x670 mm | | | | |
| 1 | Georgian bars - Sprossen - Croisillons - La griglia georgiana - Raamverdeling - Petteliistud |  | 1 | 15x25 | 660 | |
| 2 | Georgian bars - Sprossen - Croisillons - La griglia georgiana - Raamverdeling - Petteliistud |  | 1 | 15x25 | 660 | |
| 3 | Batten - Deckleiste - Profils de finition angles a l'exterieur - Asse Afdek lijst - Katteliist |  | 1 | 15x25 | 710 | |
| HS1 | Screw for georgian bars - Schraube für sprossen - Vis pour croisillons - Viti per unire la griglia georgiana della finestra - Schroeven voor raamverdeling - Kruvi akna petteliistule |  | 4 | 2.5x20 | | |
| HS10 | Screw for window hinge - Schraube für fenster scharnier - Vis pour Fenetre charniere - Viti per cerniera a finestra - Schroef voor raam scharnier - Kruvi akna polthingele |  | 4 | 4x25 | | |
| HS10 | Screw for window fixator - Fensterfixierung - Fenžtre fixator - Vite per fissatore di finestra - Schroef voor raambevestiger - Kruvi akna fiksaatorile |  | 6 | 4x25 | | |
| NF2 | Zn nail - Zn nägel - Pointe - Chiodi - Nagel - Nael |  | 5 | 1.4x40 | | |
| NA1 | Hinge for window - Scharnier für fenster - Charniere pour fenetre - Cerniere per Finestra - Raam scharnier - Aknahing |  | 2 | | | |
| NA2 | Hinge for window - Scharnier für fenster - Charniere pour fenetre - Cerniere per Finestra - Raam scharnier - Aknahing |  | 2 | | | |
| NA3 | Window fixator - Fensterfixierung - Fenžtre fixator - Fissatore della finesra - Raam(ver)dichting - Akna fiksaator |  | 1 | | | |
| NA4 | Window fixator - Fensterfixierung - Fenžtre fixator - Fissatore della finesra - Raam(ver)dichting - Akna fiksaator |  | 1 | | | |
| NA5 | Window fixator - Fensterfixierung - Fenžtre fixator - Fissatore della finesra - Raam(ver)dichting - Akna fiksaator |  | 1 | | | |

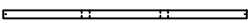
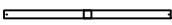
| Pos | 19.12.2017 | Piece list - Stückliste - Liste des pièces - Elementi - Stuklijst - Tükítabel 14 94x1850 TUK.2.056.SVP.MMX28 SGA+28 | 1/2 | Q | P (mm) | L (mm) |
|--|---|--|---|---|-----------|-----------|
| Glass size - Glasgröße - Taille de la vitre - Misura del vetro - Glas afmeting - Klaasi mõõt: 502x750 mm | | | |  <p>1418x1794 mm</p> | | |
|  | | | | | | |
| 1 | Upper door jamb - Türrahmen oben - Cadre de porte supérieur - Telaio superiore della porta - Bovendorpel - Ukse ülemine leng | |  | 1 | 66x100 | 1628 |
| 2 | Left door jamb - Türrahmen links - Cadre de porte gauche - Telaio montante sinistro della porta - Linkerstijl deurframe - Ukse vasak leng | |  | 1 | 66x80 | 1850 |
| 3 | Right door jamb - Türrahmen rechts - Cadre de porte droit - Telaio montante destro della porta - Rechterstijl deurframe - Ukse parem leng | |  | 1 | 66x80 | 1850 |
| 4 | Doorstep - Swelle - Barre de seuil - Soglia della porta - Deurdorpel - Lävepakk | |  | 1 | 20x21 | 1418 |
| 5 | Connection strip - Deckleiste - Baguette de battement - Profilo verticale della porta - Stulplijst - Kokkuvalltsiliist | |  | 1 | 13x32 | 1812 |
| 6 | Georgian bars - Sprossen - Croisillons - La griglia georgiana - Raamverdeling - Petteliistud | |  | 2 | 15x25 | 784 |
| 7 | Georgian bars - Sprossen - Croisillons - La griglia georgiana - Raamverdeling - Petteliistud | |  | 4 | 15x25 | 536 |

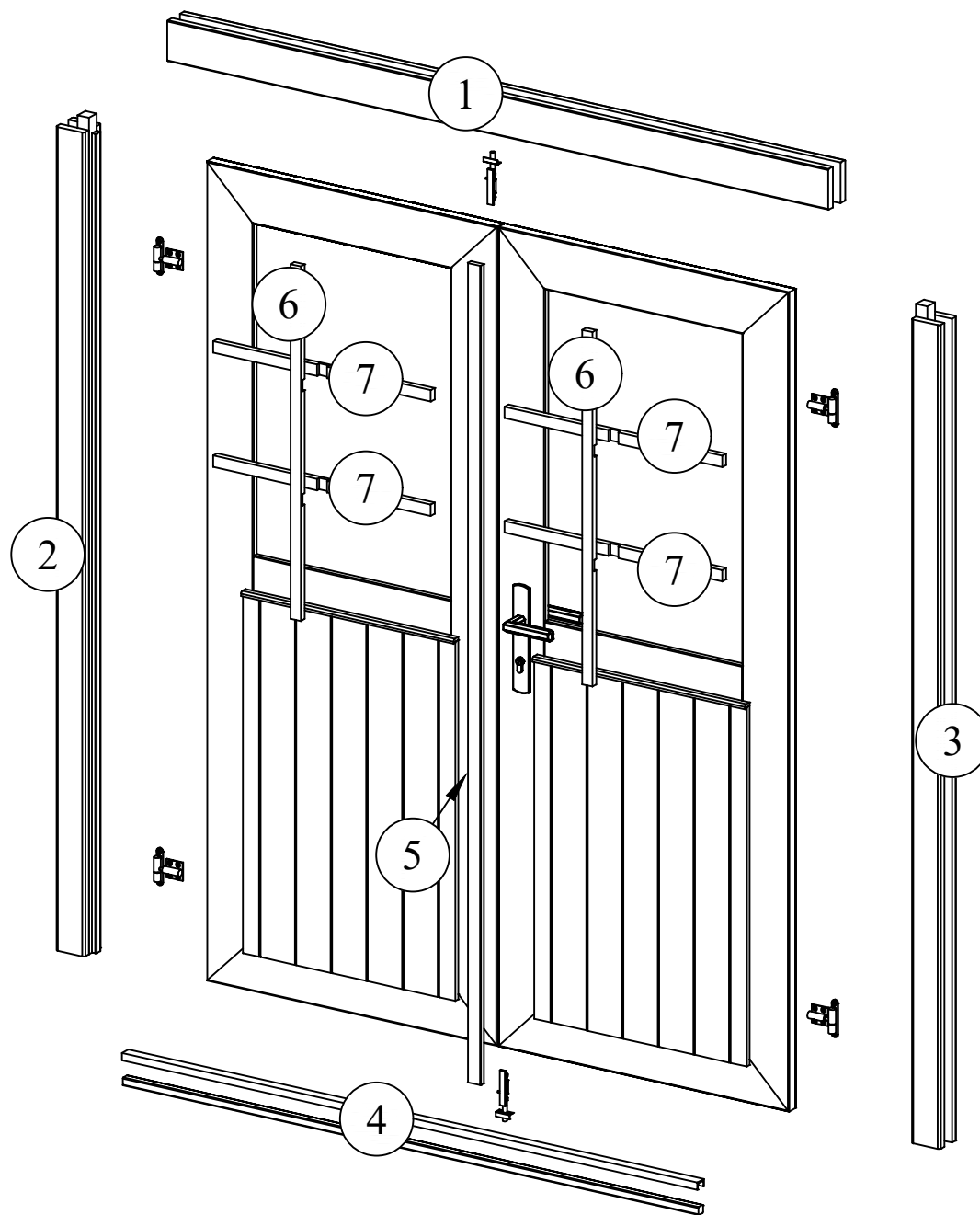

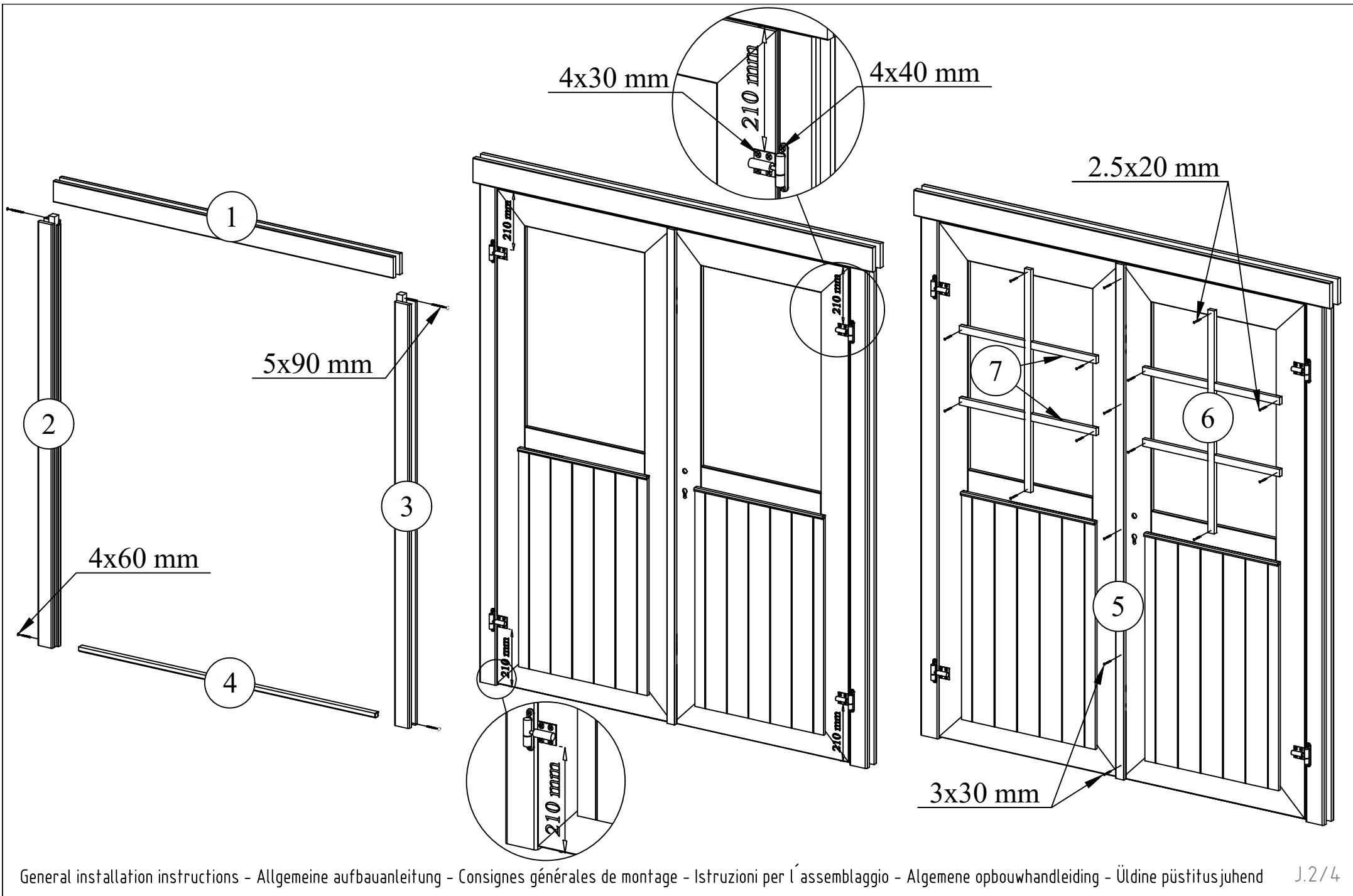

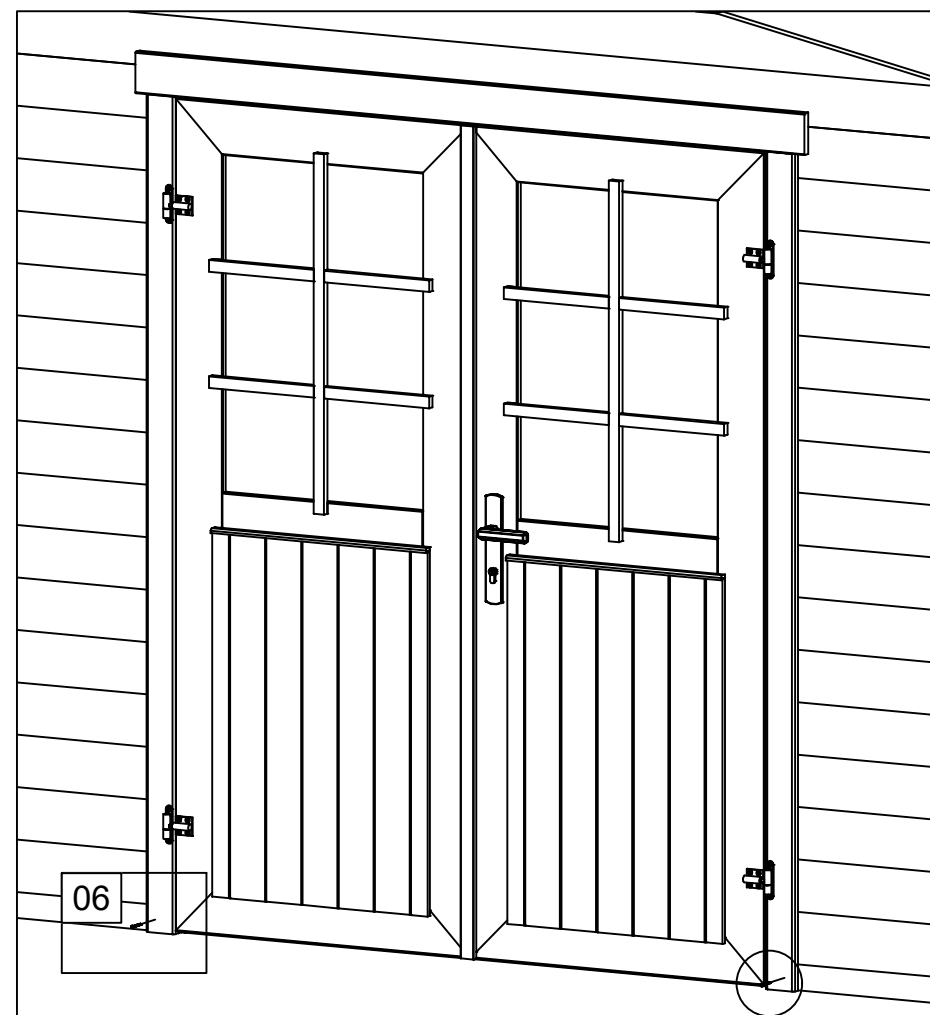
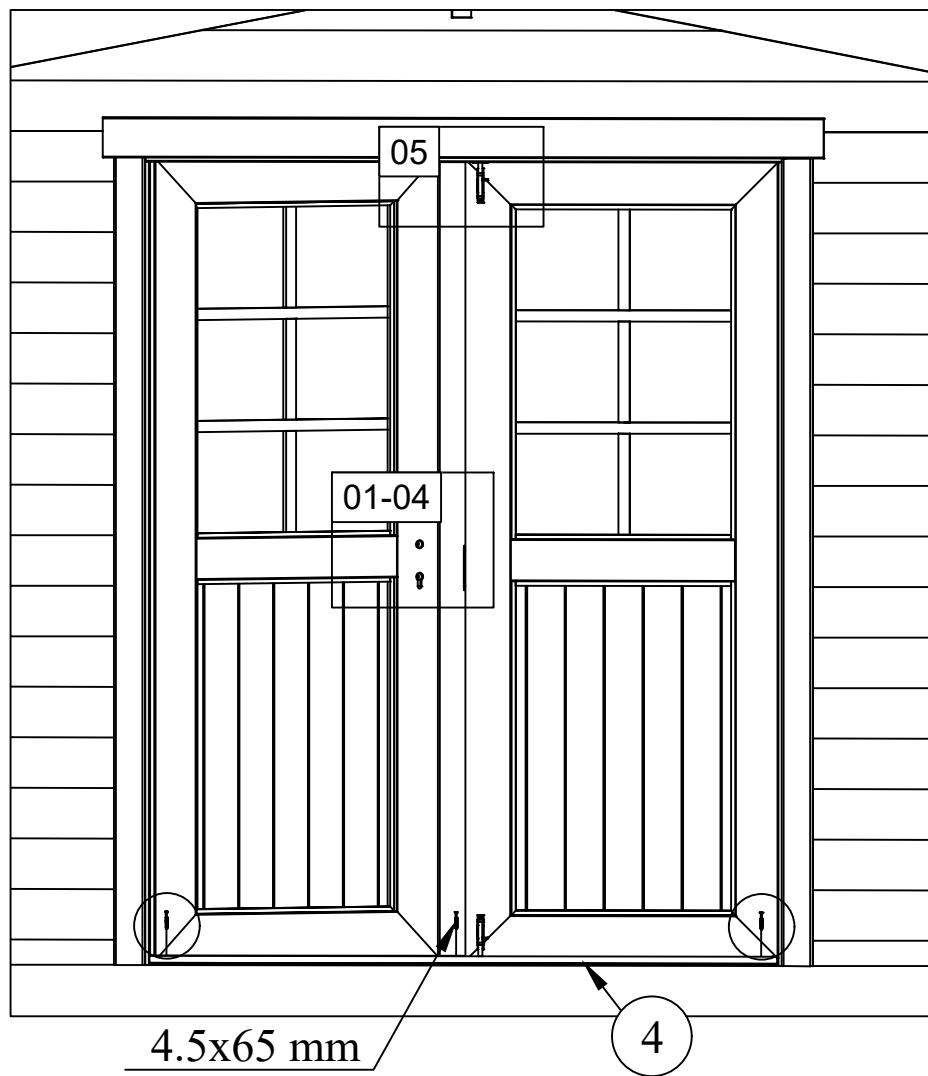

01

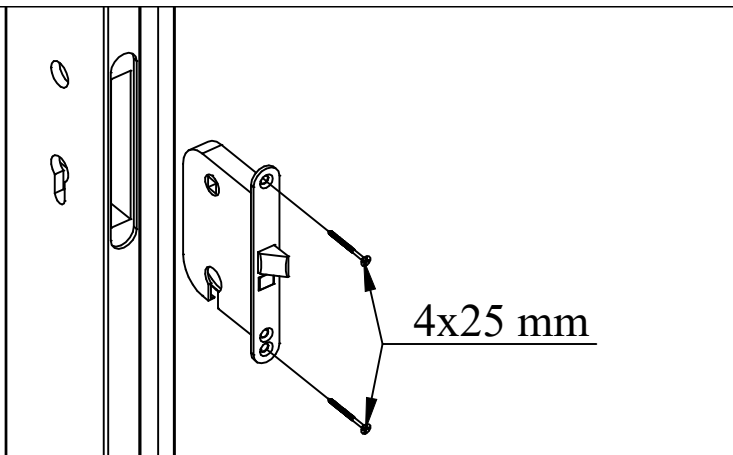

04

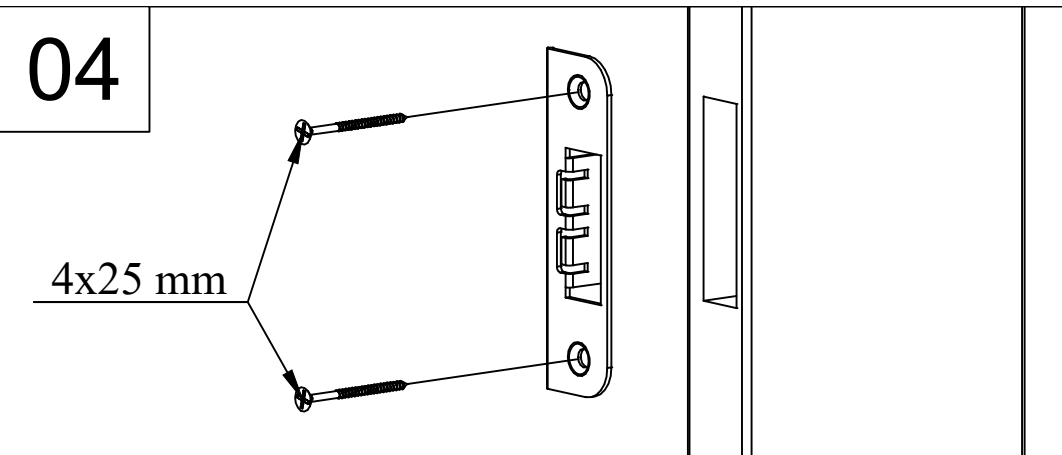

02

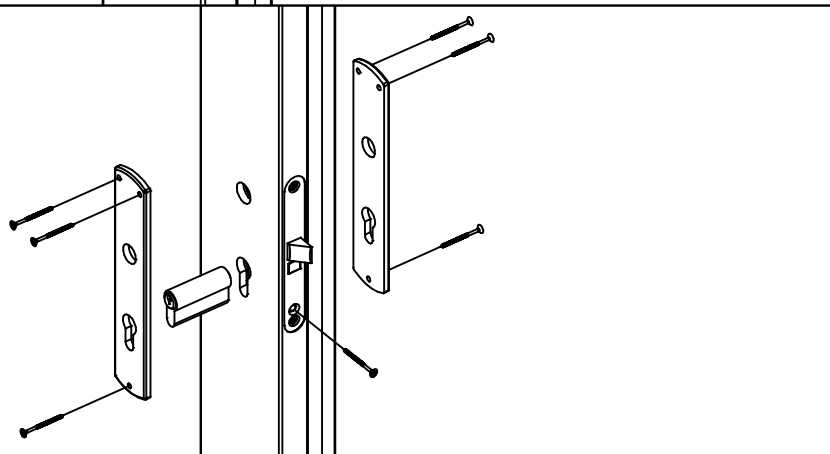

05

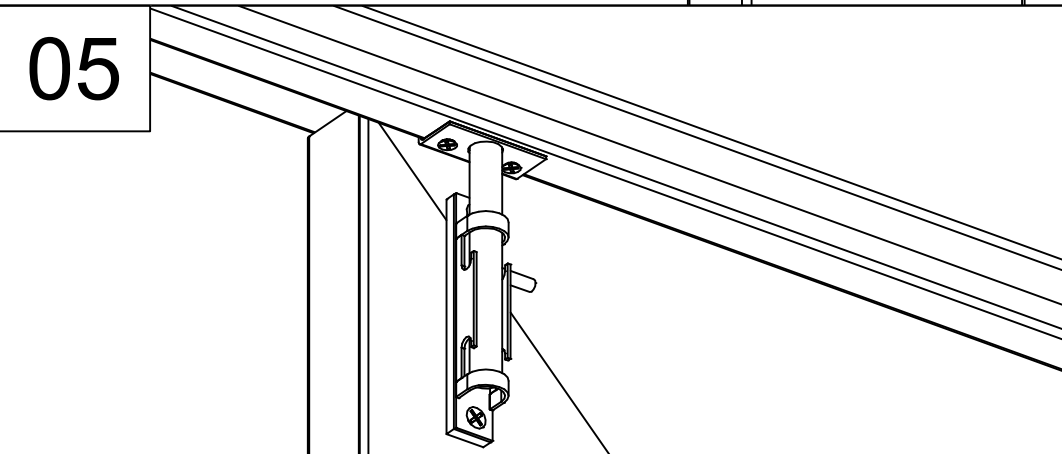

03

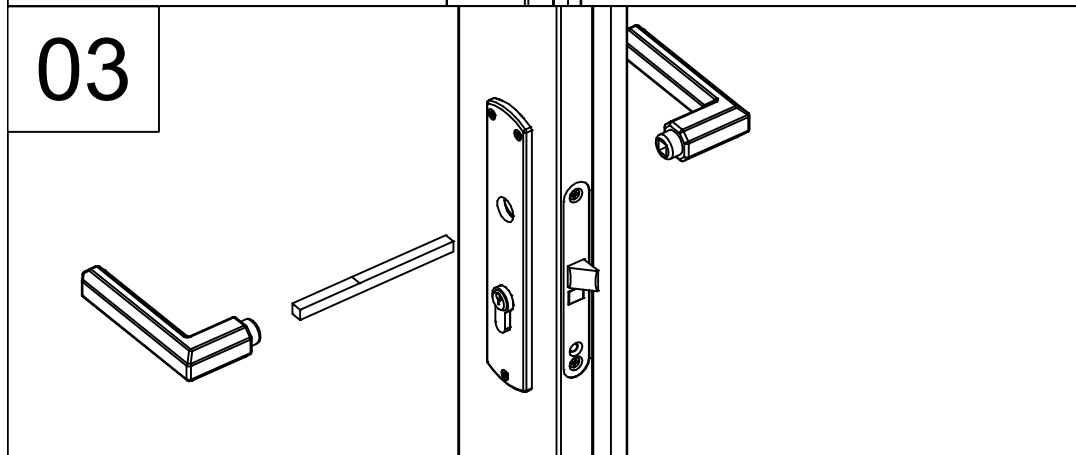

06

