

EINBAUANLEITUNG „Innenverkleidung NEO“

- Ⓜ GB Assembly manual for “Interior Panelling NEO”
- Ⓜ FR Notice de montage “Revêtement intérieur NEO”
- Ⓜ NL Opbouwbeschrijving „Binnenbekleding NEO“
- Ⓜ ES Instrucciones de montaje „Revestimiento interior NEO”
- Ⓜ IT Istruzioni di montaggio „Rivestimento interno NEO”
- Ⓜ DK Installationsvejledning til „NEO indvendig foring“

For further languages please go to: www.biohort.com/downloads



QUALITÄT AUS
ÖSTERREICH

1 PANEEL-PAKET

Panel package · Carton de parois · Zijwandpakket · Panel la teral · Pacco pareti · Pladepakke

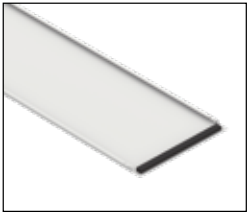

2 ECKPANEEL-PAKET

Corner panel package · Colis des parois d'angle · Hoekpaneel pakket · Paquete de paneles de esquina · Pacchetto pannello angolare · Hjørnepanel pakke

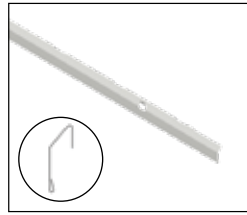
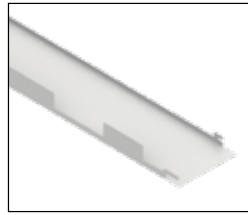
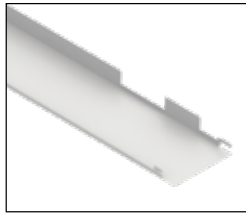
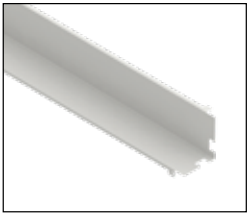

ISOLIERUNG

Insulation · Isolation · Binnenbekleding · Isolación · Isolamento · Isolering

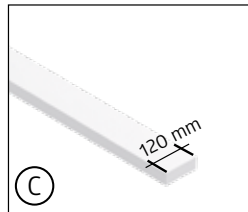
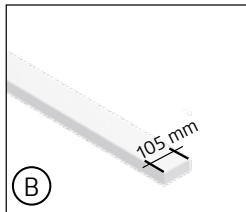
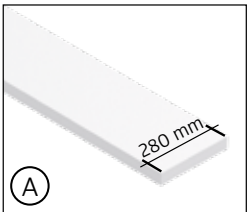



Isolierung

Insulation · Isolation · Binnenbekleding · Isolación · Isolamento · Isolering

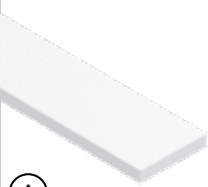
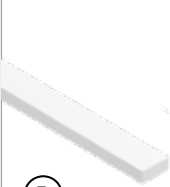
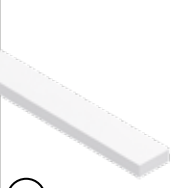
 <p>(A)</p>	<p>Standardtür</p> <p>1A: 17x</p> <p>2A: 21x</p> <p>1B: 21x</p> <p>2B: 24x</p>	<p>Doppeltür</p> <p>1B: 17x</p> <p>2B: 21x</p>	 <p>(B)</p>	<p>Standardtür</p> <p>1A: 9x</p> <p>2A: 9x</p> <p>1B: 9x</p> <p>2B: 9x</p>	<p>Doppeltür</p> <p>1B: 9x</p> <p>2B: 9x</p>
	 <p>(C)</p>	<p>Standardtür</p> <p>1A: 1x</p> <p>2A: 1x</p> <p>1B: 1x</p> <p>2B: 1x</p>		<p>Doppeltür</p> <p>1B: 1x</p> <p>2B: 1x</p>	

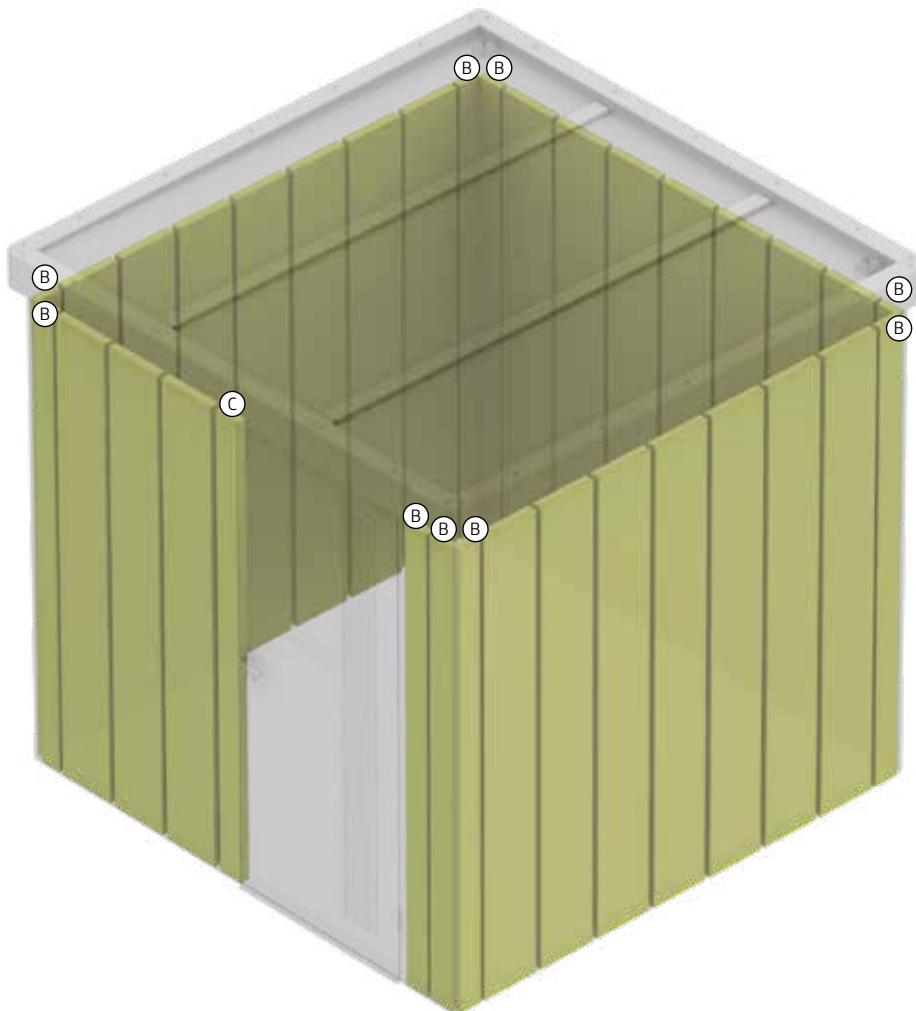

1.

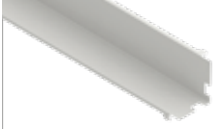

Standardtür	Doppeltür
1A: 4x	1B: 4x
2A: 4x	2B: 4x
1B: 4x	
2B: 4x	

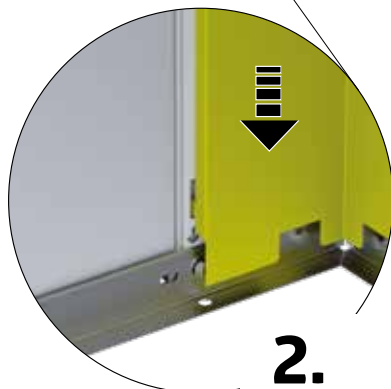
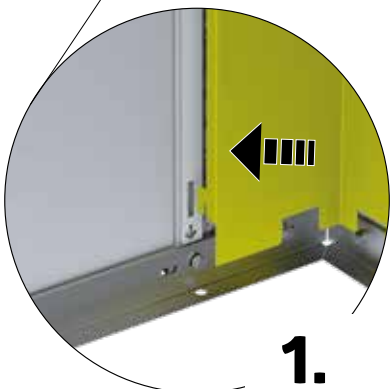
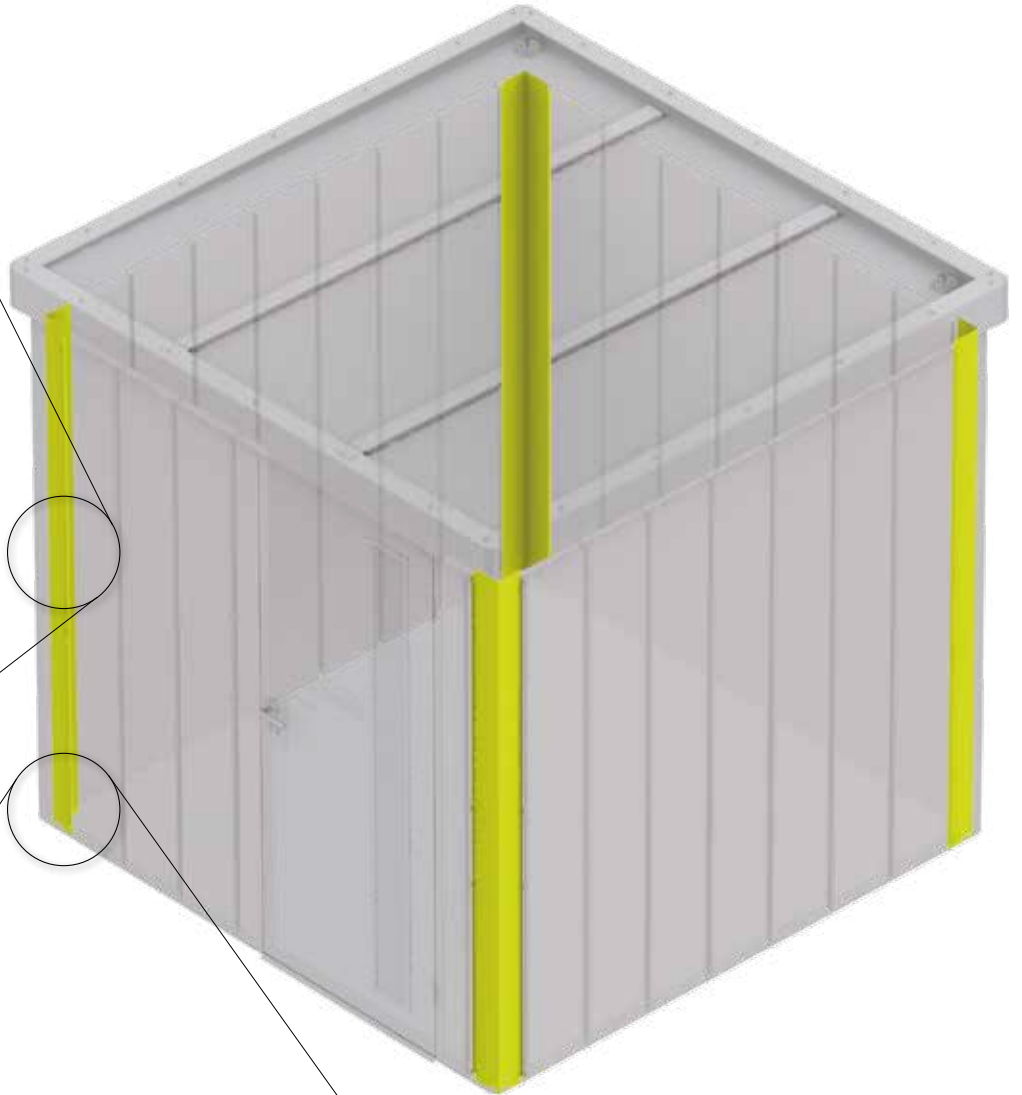
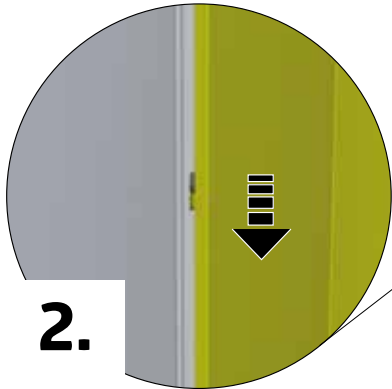
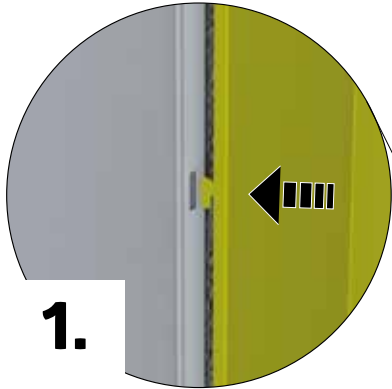

2.

	Standardtür	Doppeltür
1A:	16x	1B: 17x
2A:	20x	2B: 21x
1B:	20x	
2B:	24x	

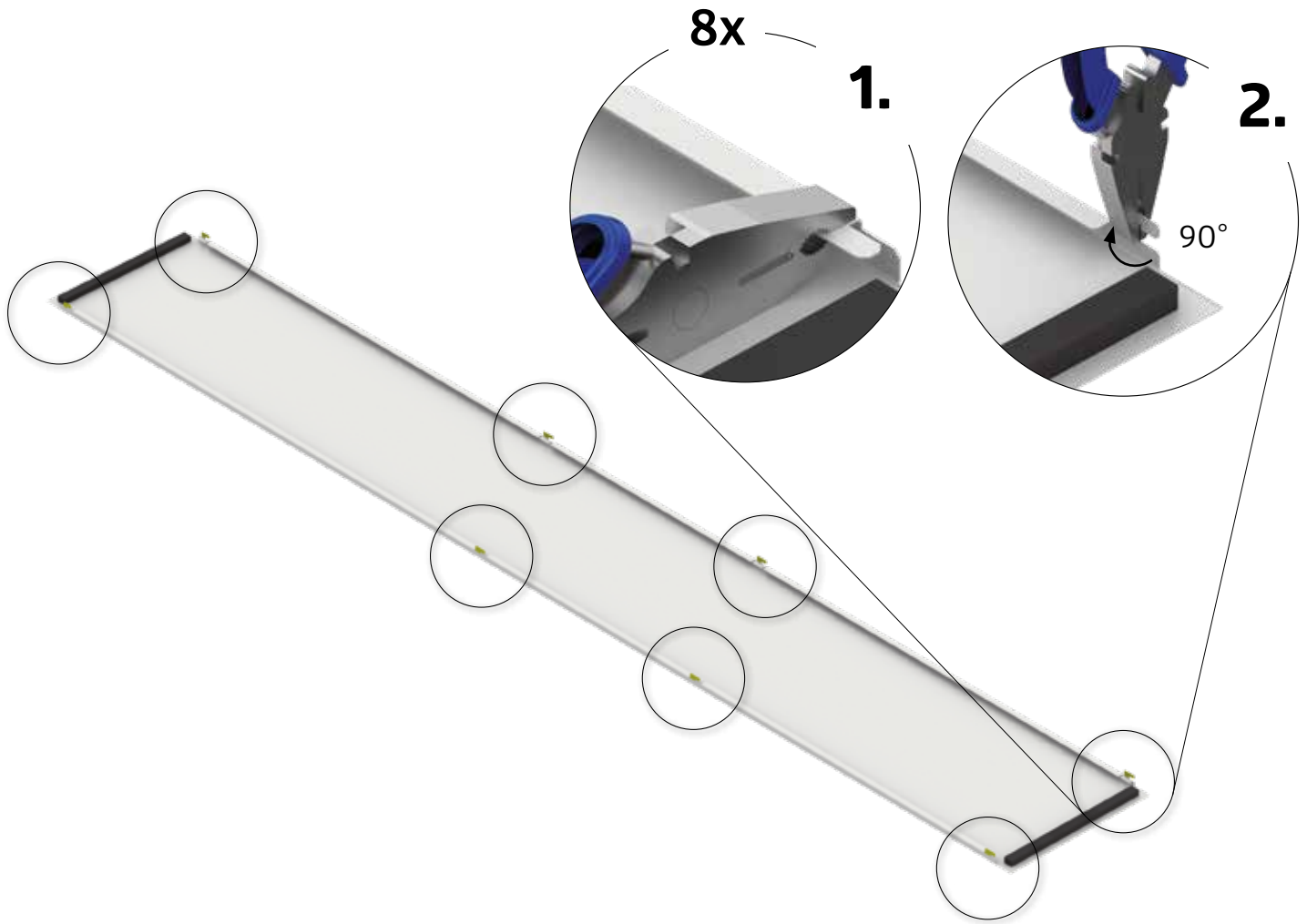

3.

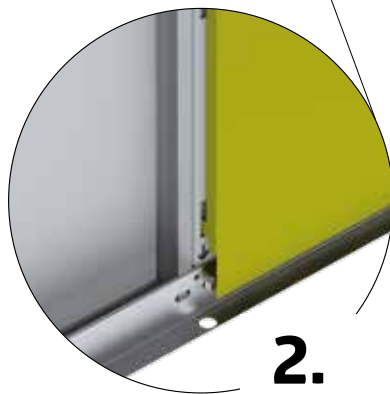
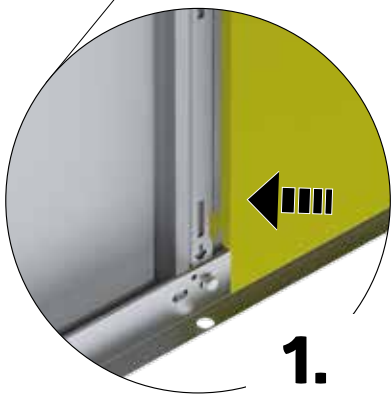
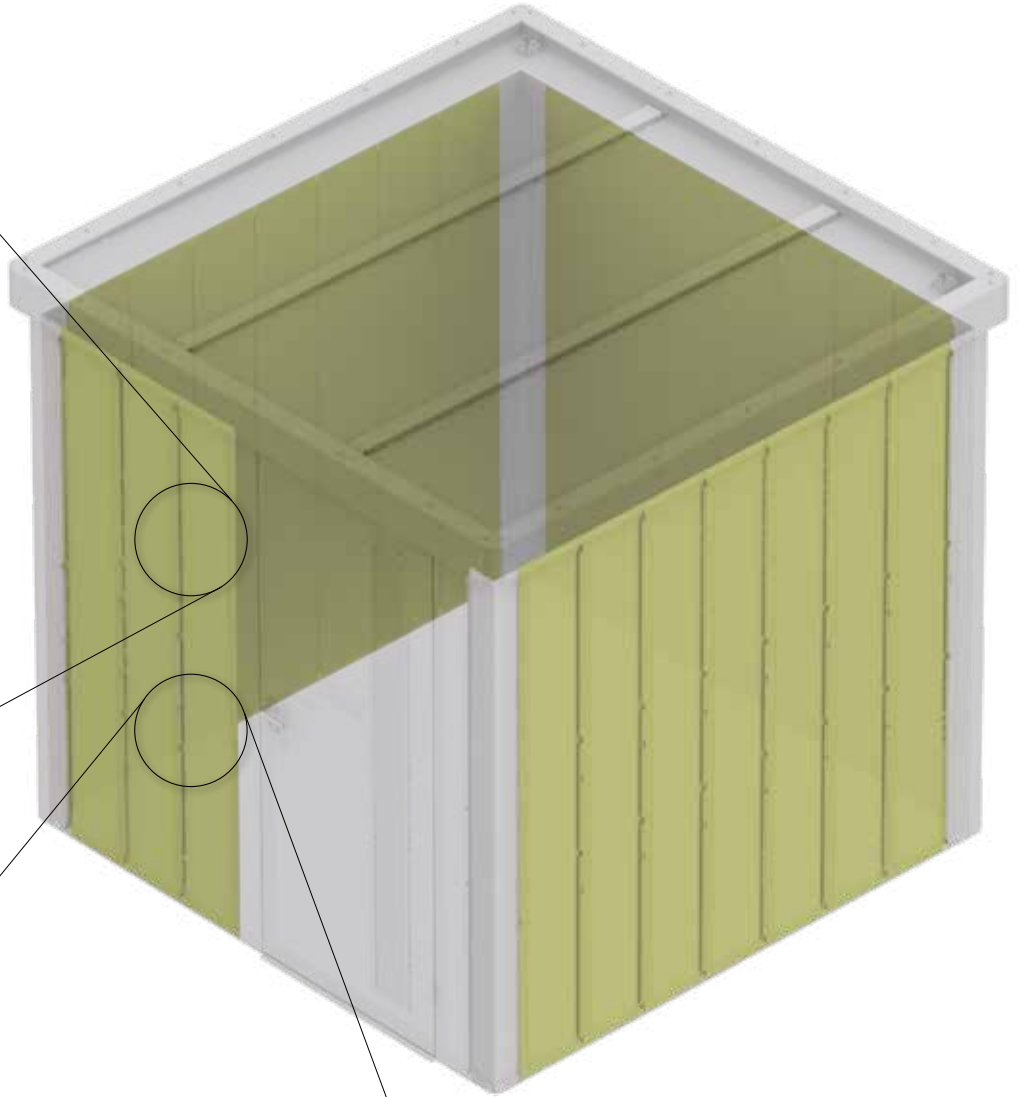
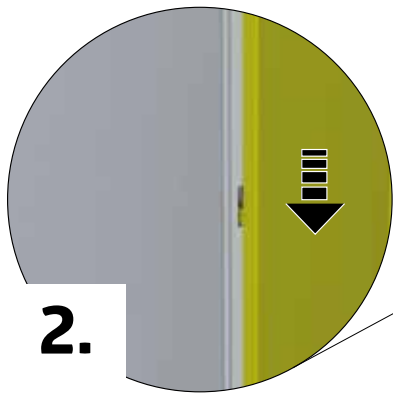
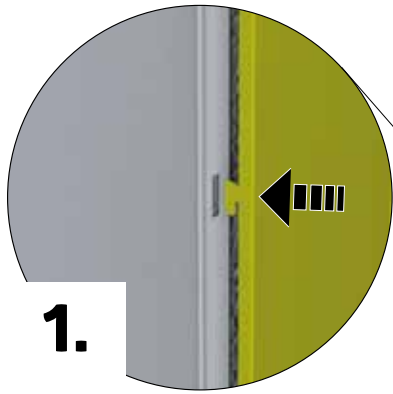

4.

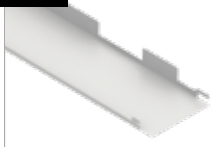
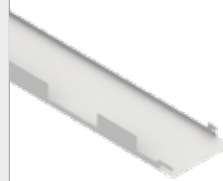
	Standardtür	Doppeltür		Standardtür	Doppeltür
	1A: 1x 2A: 1x 1B: 1x 2B: 1x	1B: 1x 2B: 1x		1A: 1x 2A: 1x 1B: 1x 2B: 1x	1B: 1x 2B: 1x



5.



Standardtür

1A: 4x
2A: 4x
1B: 4x
2B: 4x

Doppeltür

1B: 4x
2B: 4x

4,8 x 13



Standardtür

1A: 16x
2A: 16x
1B: 16x
2B: 16x

Doppeltür

1B: 16x
2B: 16x

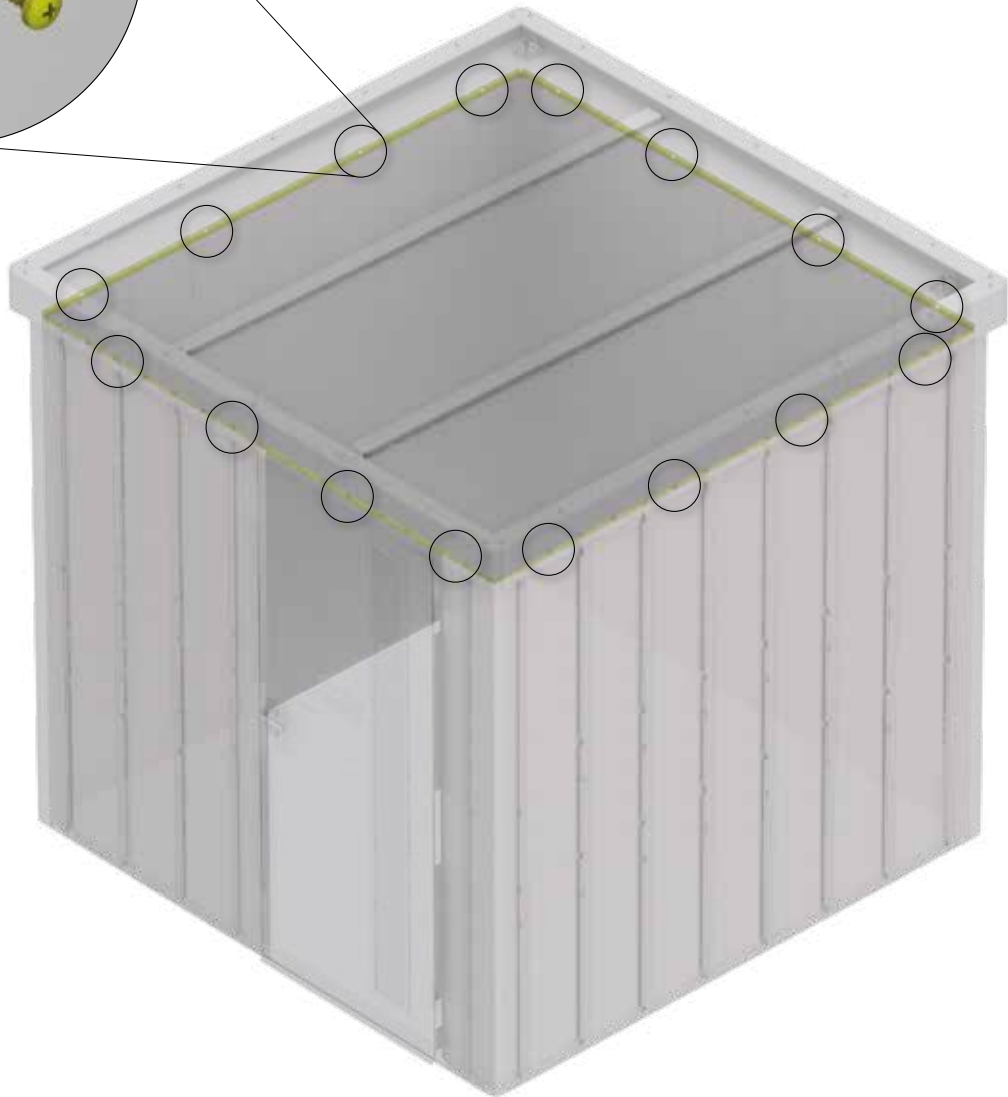
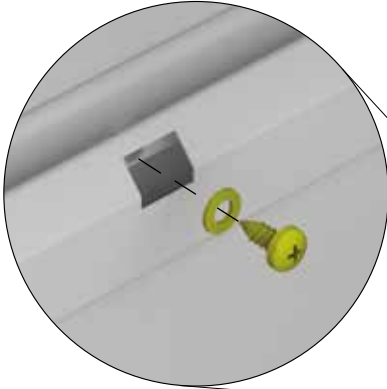

Kontrollnummer:
Control-number / Contrôle-Qualité / Controlnummer:

Bei Reklamationen bitte anführen:
Kontrollnummer und Artikelnummer des reklamierten Teils.

GB: In case of complaint please indicate the control-number and the number of the item, which is subject of complaint.

F: Pour toutes réclamations: prière de joindre le numéro de contrôle et le numéro d'article de la pièce litigieuse.

NL: Bij reclamaties svp doorgeven: controlnummer en artikelnummer van het desbetreffende onderdeel.

Y1046051_0621



Biohort GmbH
Pürnstal 43, 4120 Neufelden, Österreich
Tel.: +43-7282-7788-0, Fax-DW: 190
E-Mail: office@biohort.at, www.biohort.com